

FLOWMETER

Ultrasonic flow transmitter

FLOWMETER
GB

Technical Data

Housing material:	PC or AI / PP wetted part
Mechanical installation:	2" GAS M on request PP flange DN80
Protection degree:	IP67 PC hous./ IP66 PBT hous.
Electrical connection:	Internal push actuators connectors
Working temperature:	-30 ÷ +70°C; +80°C non-continuous
Pressure:	from 0,5 to 1,5 bar (absolute)
Power supply:	24Vdc
Power consumption:	1,5W
Analog output:	4÷20mA max 750ohm
Relè in uscita:	n°2 3A 230Vac (n.a.)
Digital communication:	MUDBUS
Measure range:	0.25÷5m
(In case of non perfectly reflecting surfaces, the maximum distance value will be reduced)	
Blind distance:	0,25m
Temperature compensation:	digital from -30 to 80°C
Accuracy:	0,2% (of the measured distance) not better than ±3mm
Resolution:	1mm
Calibration:	4 buttons or by MUDBUS
Warm-up:	1 minute typical
LCD Display:	Plug-in display/keyboard 4 buttons matrix LCD



FLOWMETER Mechanical Installation

Important!!! close to the sensor there is a "blind zone" of 0.25m where the instrument can't measure (see fig.2). To reach a good and safe measurement, avoiding spurious echoes (not reflected by the surface), take care of the positioning of the FLOWMETER sensor and check that no obstacles are interfering with the ultrasonic waves emission lobe.

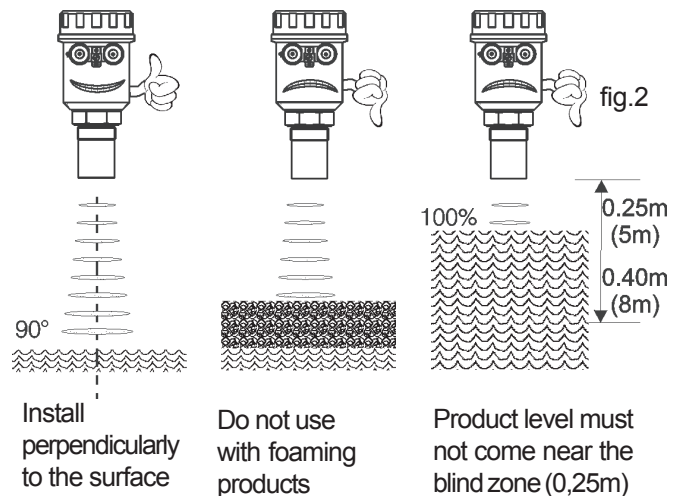
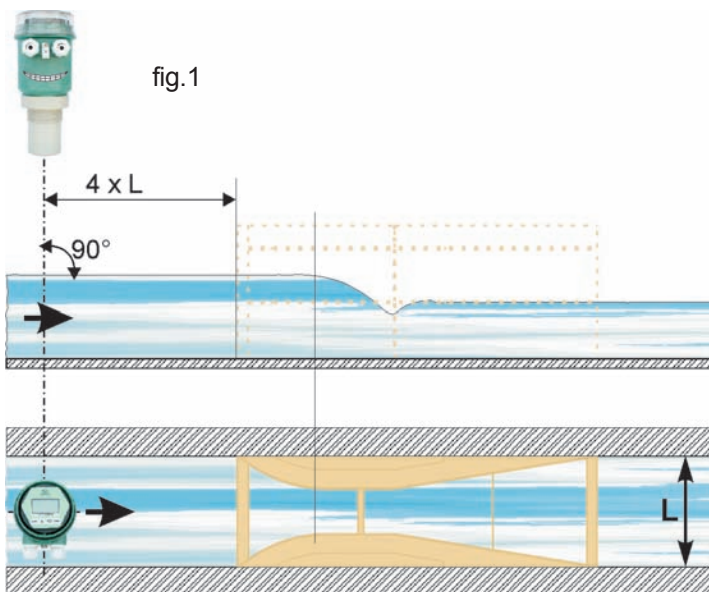

1. DIMENSIONS

1.1 F cod. housing

FLOWMETER transmitter dimension with the loaded polycarbonate (PC) housing

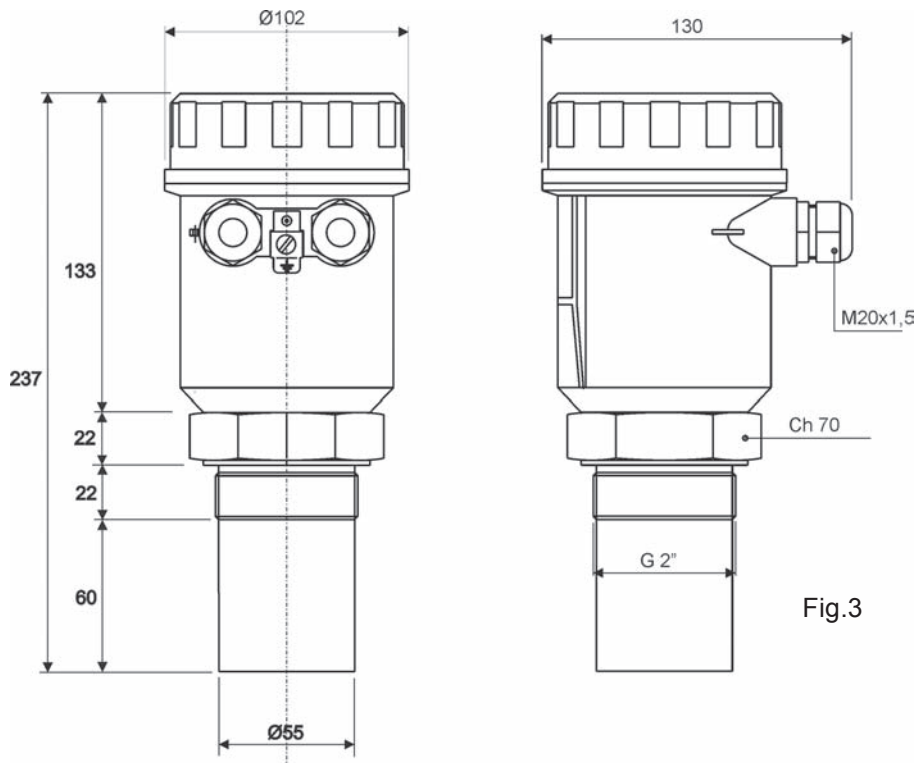

Fig.3

1.5 U cod. housing

FLOWMETER transmitter dimension with the aluminum housing

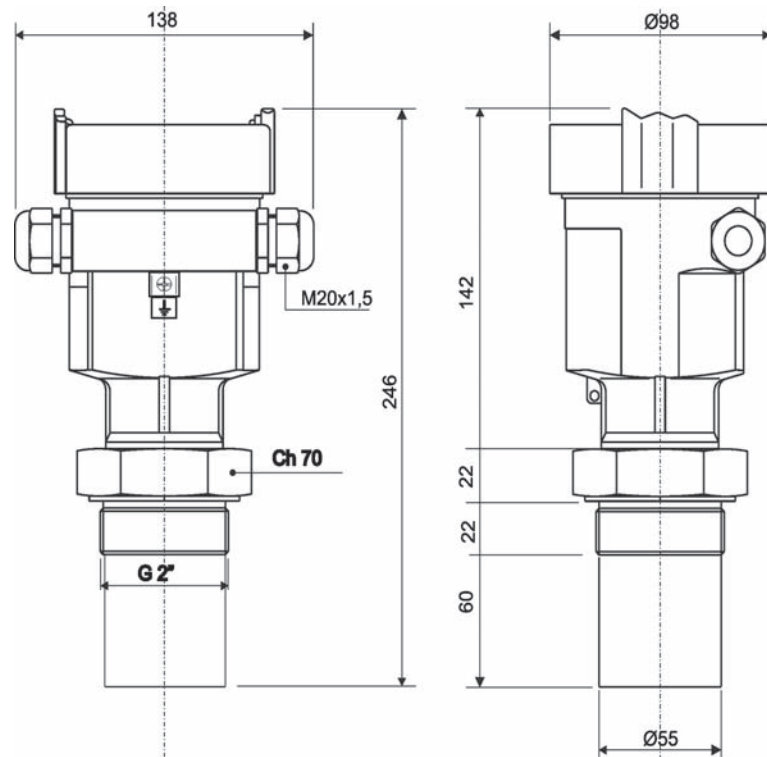

Fig.4

2. CONNECTIONS

Unscrew the cover to reach the terminal boards.

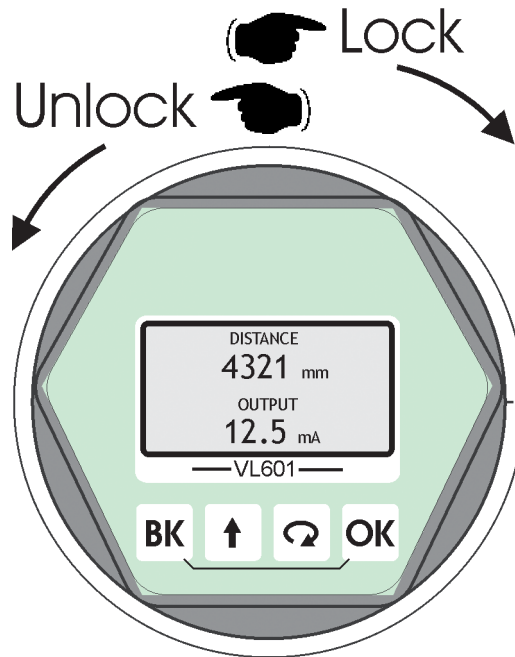

Fig.5

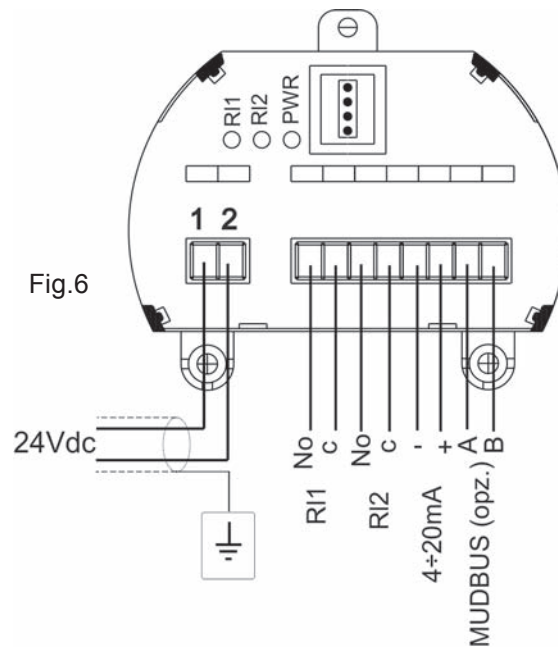

Fig.6

3. CONFIGURATION

The METER configuration and calibration can be done in two different ways:

- by the PC (via **MODBUS**)
- by the **VL601** plug-in / keyboard module

3.2 Via MODBUS

3.2.1 MODBUS PC connection(fig.7)

- 1) RS232 connector
- 2) FLOWMETER with MODBUS communication protocol
- 3) RS485/RS232 converter module

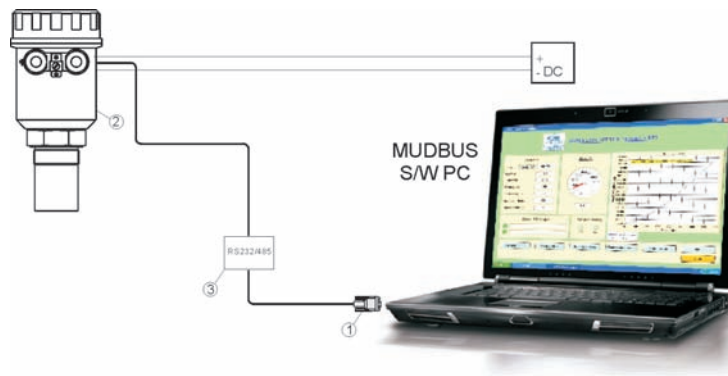

Fig.7

3.3 Via VL601

3.3.1 Keyboard/display module VL601 (fig.9)

The display module VL601 can be easily mounted and removed without affecting the METER running. Unscrew the transparent cap and turn the display clockwise to mount it, or anticlockwise to remove it (fig.8).

The VL601 module has a large matrix LCD (fig.9).

It is possible to choose the measurement display of 1 value (big characters, fig 9b) or of 2 values (small characters, fig 9c).

The operating manual allows an easy and fast start-up through the keyboard.

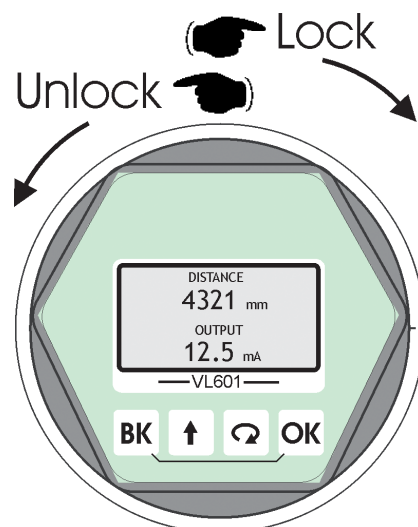

Fig.8

4. VL601 MODULE

From "RUN" mode, press **OK** to enter "PROGRAM" mode. Press **BK** to quit

Press **↻** to move the cursor on the parameter you want to use and confirm with **OK**

To edit numbers, press **↑** to modify the digit shown in negative, press **↻** to edit the next digit, press **OK** to confirm and store the number. Press **BK** to quit

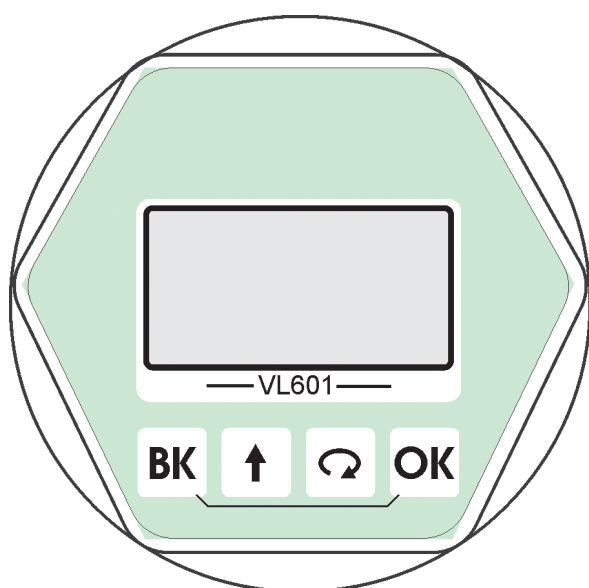
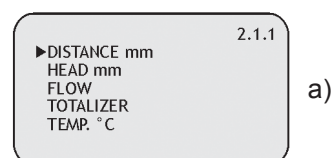

Fig.9

Note. The five selectable values are displayed on window 2.1.1



a)



b)

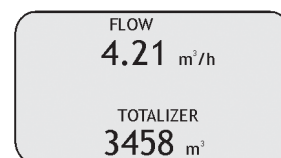

c)

- OK** - Configuration access
- Options confirmation
- Parameters values confirmation

- ↻** - Parameters values selection
- Parameters scroll

- ↑** - Parameters values modification

- BK** - Exit configuration
- Back to previous menu

5. PROGRAMMING MENU

1. **SETUP** - in this menu it's possible to set the basic adjustment of the sensor (fig. 10).
2. **DISPLAY** - in this menu it's possible to setup the sensor display mode and adjust the B/W contrast of LCD (fig. 11).
3. **FOLW APPL.** - in this menu it's possible to test and check the sensor, display peak values and measure status (fig. 12).
4. **SERVICE** - in this menu it's possible to set com mode, output mode, language, input password to enable parameters (fig. 13).
5. **INFO** - this menu show firmware revision, serial number and manufacturer information (fig. 14).

5.1 SETUP

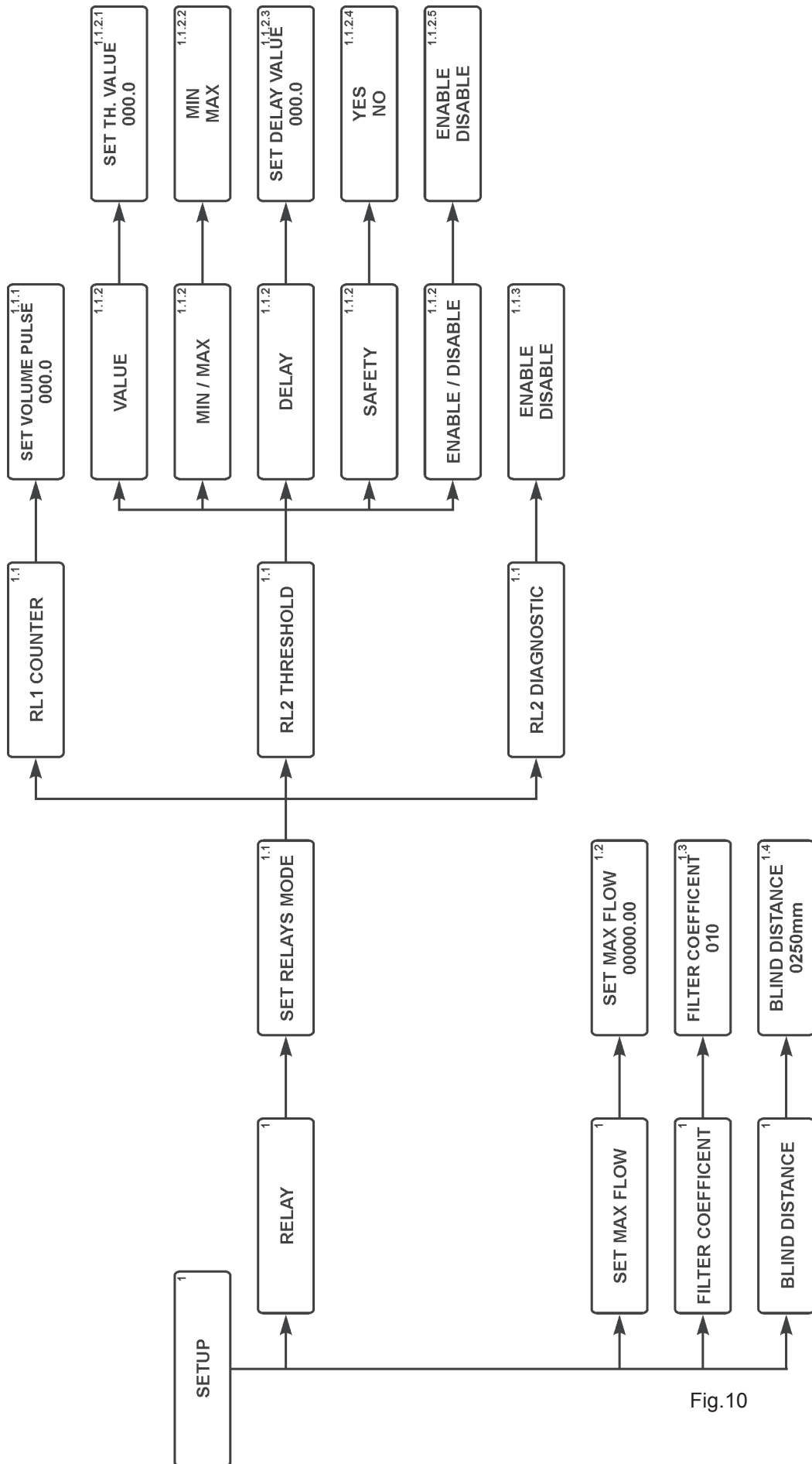

Fig.10

5.1 DISPLAY

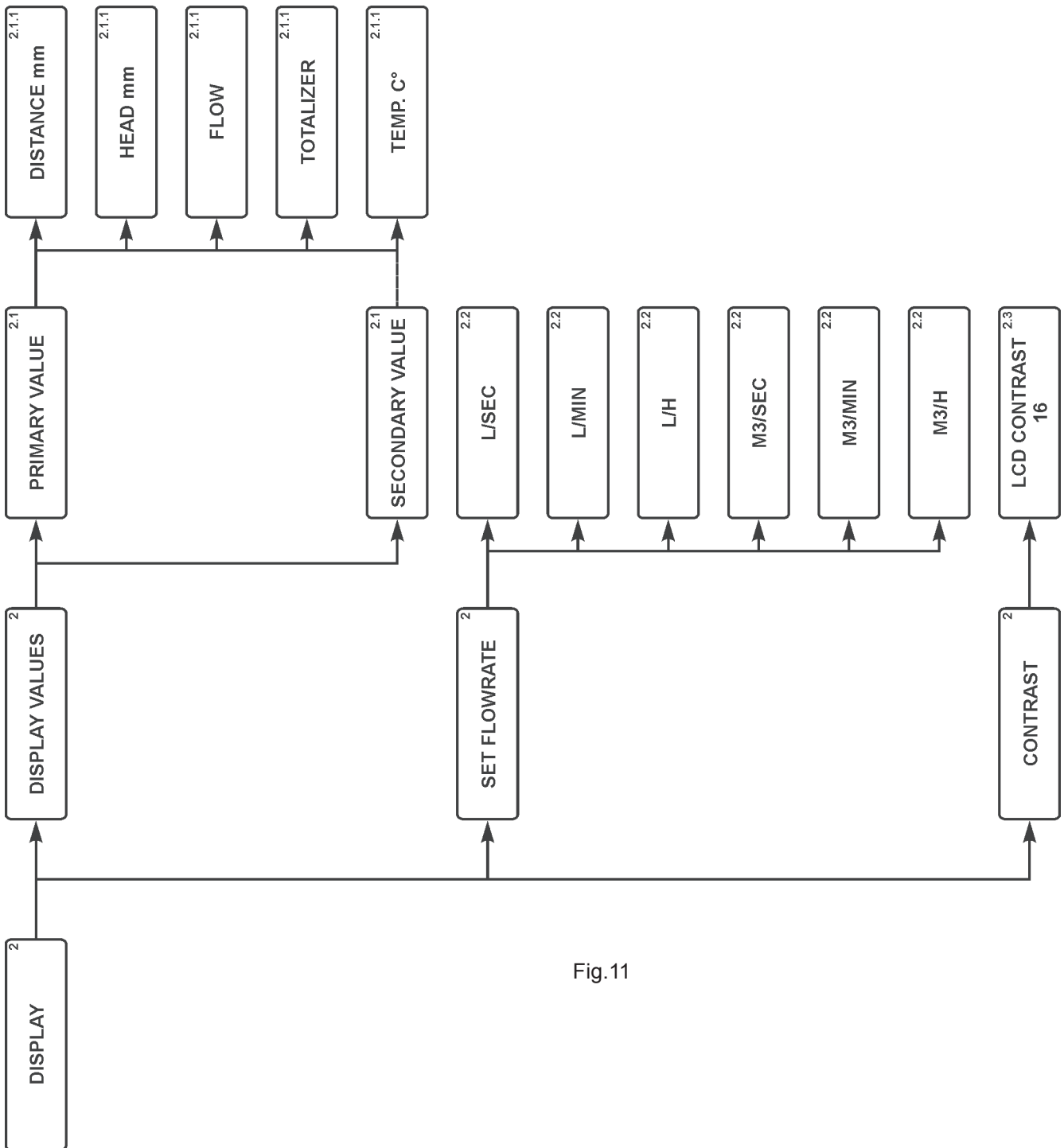

Fig.11

5.3 FOLW APPL.

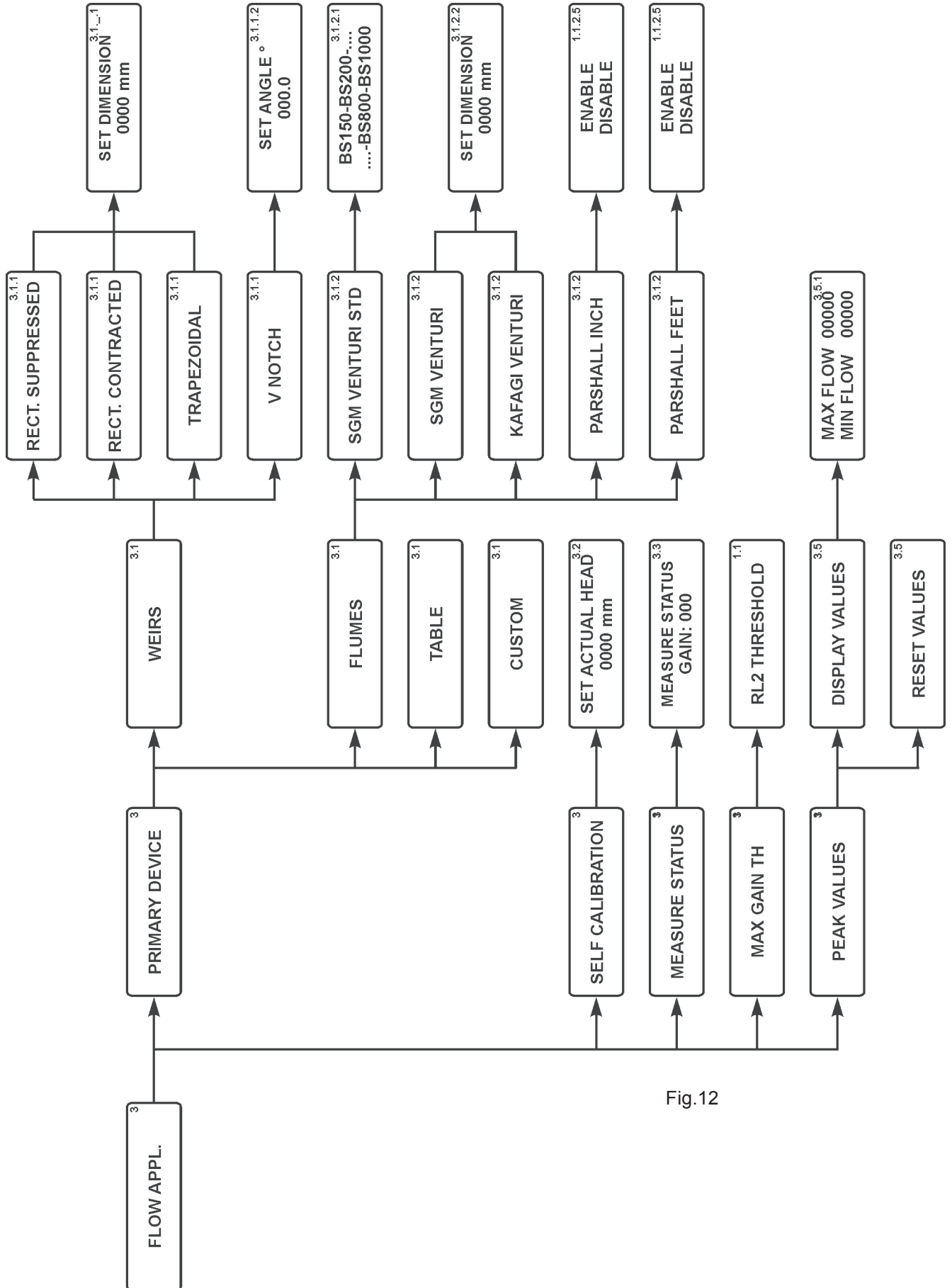

Fig. 12

5.4 SERVICE

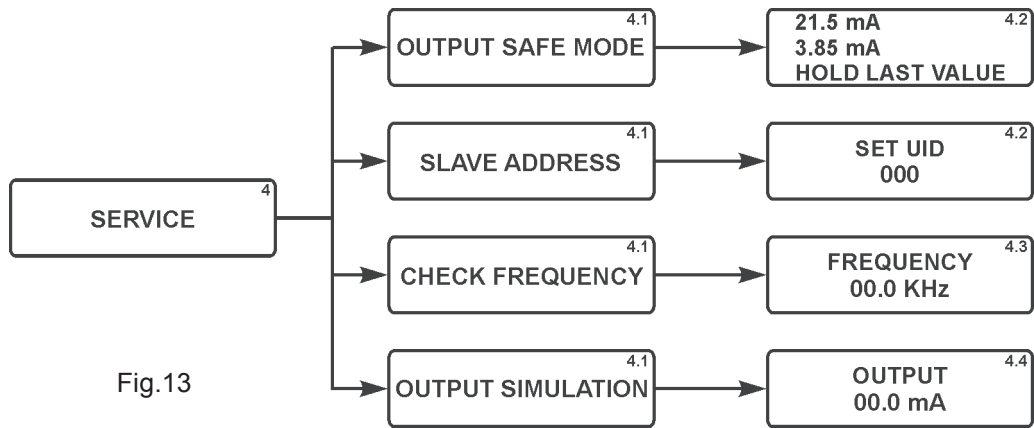

Fig.13

5.5 INFO



Fig.14

6. CONFIGURATION

6.1 SETUP (1)

From "RUN" mode, press **OK** then move the cursor on "SETUP" and confirm with **OK**

▶SETUP
DISPLAY
FLOW APPL.
SERVICE
INFO

6.1.1 RELAY

In this sub-menù it's possible to setup onboard relays. RL1 is enabled to do a counter for the measured volume; RL2 can be set as threshold relay or diagnostic relay

Select the parameters by moving the cursor with **↶** and confirm with **OK**

▶RELAY 1
SET MAX FLOW
FILTER COEFFICIENT
BLIND DISTANCE

6.1.1.1 RL1 COUNTER

it's possible to input the measured volume that is associated to a pulse.

To edit numbers, press **↑** to modify the digit shown in negative, press **↶** to edit the next digit.

With a value of 000.0 the function is disabled

Press **OK** to confirm

SET RELAY MODE 1.1
▶RL1 COUNTER
RL2 THRESHOLD
RL2 DIAGNOSTIC

SET VOL/PULSE 1.1.1
000.0

6.1.1.2 RL2 THRESHOLD

Select the parameters by moving the cursor with **↶** and confirm with **OK**.

SET RELAY MODE 1.1
RL1 COUNTER
▶RL2 THRESHOLD
RL2 DIAGNOSTIC

▶VALUE 1.1.2
MIN / MAX
DELAY
SAFETY
ENABLE / DISABLE

6.1.1.2.1 VALUE

It's possible to input the threshold value, in terms of percentage of flow.

To edit numbers, press **↑** to modify the digit shown in negative, press **↶** to edit the next digit.

Press **OK** to confirm



▶VALUE 1.1.2
MIN / MAX
DELAY
SAFETY
ENABLE / DISABLE

SET TH. VALUE 1.1.2.1
000 %

FLOWMETER - Configuration

6.1.1.2.2 MIN / MAX

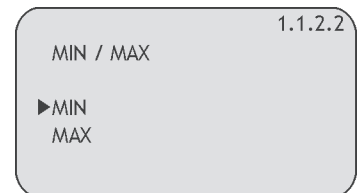
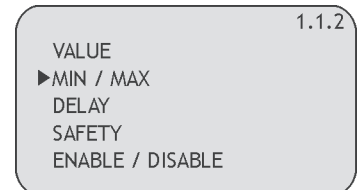

It's possible to select if the relay works as maximum level threshold or minimum level threshold

Select by moving the cursor with  and confirm with .



6.1.1.2.3 DELAY

It's possible to select the delay of activation for the selected relay, from 0 to 99 sec. (0s default).

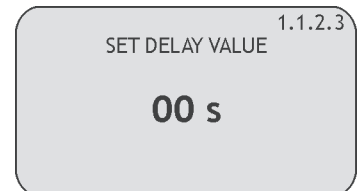
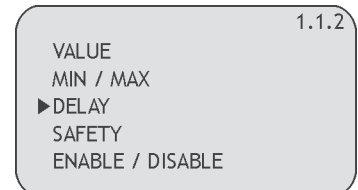

To edit numbers, press  to modify the digit shown in negative, press  to edit the next digit.

Press  to confirm



6.1.1.2.4 SAFETY

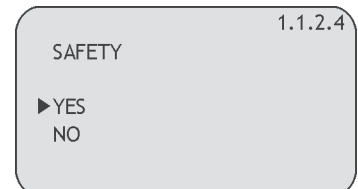
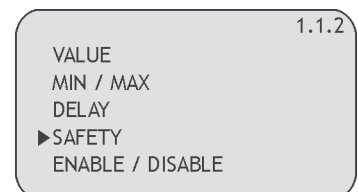

It's possible to select if the coil of relay is normally EXCITED (YES) or normally DISEXCITED (NO).

Select by moving the cursor with  and confirm with .



6.1.1.2.5 ENABLE/DISABLE

Select ENABLE to allow the relay to work in the selected mode (Threshold/Pump or Threshold/Diagnostic)

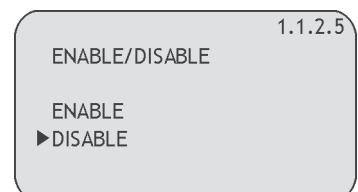
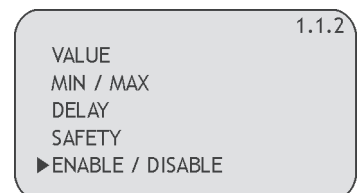

Select by moving the cursor with  and confirm with .



6.1.1.3 RL2 DIAGNOSTIC

it's possible to enable RL2 to activate its contact in case of error as:

- TEMP, temperature out of range
- ECHO, no echo is detected
- GAIN, the sensor's gain exceed the value setted in Max Gain TH (3.4)
- FLOW, the measured flow exceed the 120% of SET MAX FLOW (1.2) in setup.

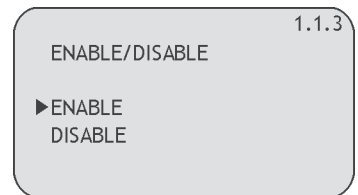
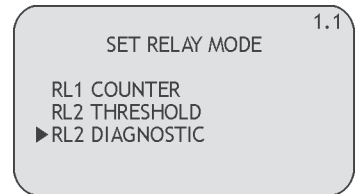

Select by moving the cursor with  and confirm with .

NOTE: when an error occurs, a "!" is flashing on the display: press  to show a message that indicate what kind of error is present.



6.1.2 SET MAX FLOW

it's possible to input the maximum value of flow (this value is associated to 20mA)

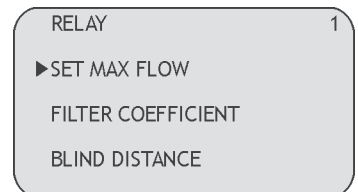

To edit numbers, press  to modify the digit shown in negative, press  to edit the next digit.

Press  to confirm



6.1.3 FILTER COEFFICIENT

input a value from 1 to 100 (10 default) to smooth the response of the sensor: the biggest is the value, the smoothest is the response

To edit numbers, press  to modify the digit shown in negative, press  to edit the next digit.

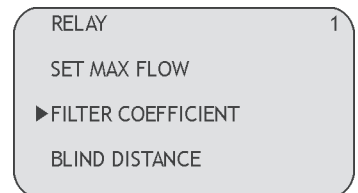

Press  to confirm



6.1.4 BLIND DISTANCE

represent the "BLIND ZONE" of the sensor. Input the desired value in order to avoid measures near the surface of the sensor (if necessary).

The minimum value is 250mm

To edit numbers, press  to modify the digit shown in negative, press  to edit the next digit.

Press  to confirm

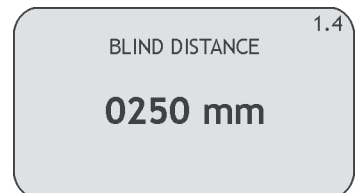
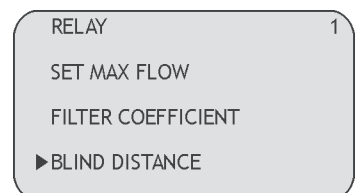

6.2 DISPLAY(2)

From "RUN" mode, press **OK** then move the cursor on "DISPLAY" and confirm with **OK**

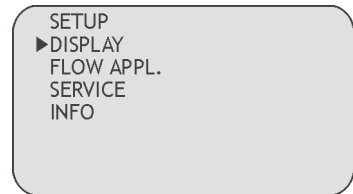

6.2.1 DISPLAY VALUE

it's possible to select if one value with big digits or two values are shown on the display in "RUN" mode. Two values are displayed; it's possible to choose which one is the primary and which is the secondary, each with a choice of 5 parameters

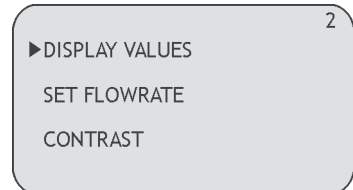

Select by moving the cursor with **↶** and confirm with **OK**

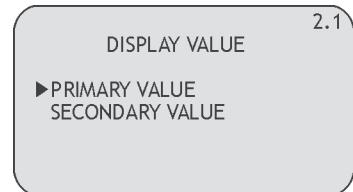

6.2.1.1 PRIMARY VALUE

To select the first data on the display.

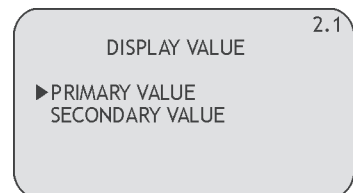

Select by moving the cursor with **↶** and confirm with **OK**

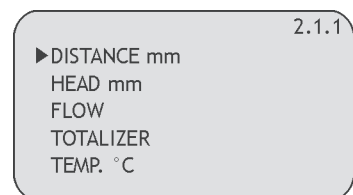

6.2.1.2 SECONDARY VALUE

To select the second data on the display.

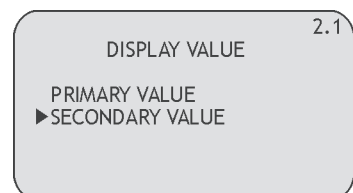

Select by moving the cursor with **↶** and confirm with **OK**

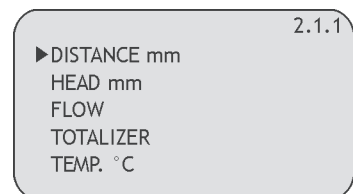

6.2.2 SET FLOWRATE

it's possible to choose the flowrate for the measured flow. This choice affects the measure unit's for the totalizer (liters or cubic meters)

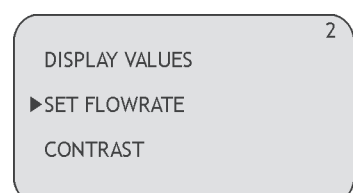

Select by moving the cursor with **↶** and confirm with **OK**

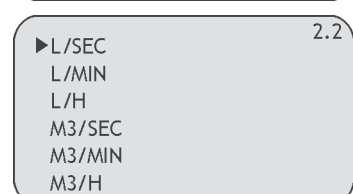

6.2.3 CONTRAST

it's possible to adjust the contrast of LCD, simply increasing or decreasing the value of a parameter from 0 to 63 (16 default)

To edit numbers, press  to modify the digit shown in negative,

press  to edit the next digit.

Press  to confirm

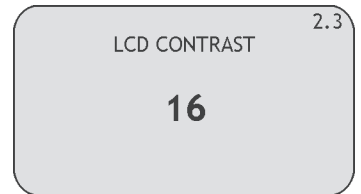
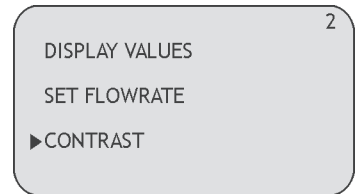

6.3 FLOW APPL. (3)

From "RUN" mode, press **OK** then move the cursor on "FLOW APPL." and confirm with **OK**

SETUP
 DISPLAY
 ▶ FLOW APPL.
 SERVICE
 INFO

6.3.1 PRIMARY DEVICE

it's possible to choose which primary device is used

▶ PRIMARY DEVICE
 SELF CALIBRATION
 MEASURE STATUS
 MAX GAIN TH
 PEAK VALUE

6.3.1.1 WEIRS

it's possible to choose from 4 type of weirs: Rectangular Suppressed, Rectangular Contracted, Trapezoidal and V Notch.

▶ WEIRS 3.1
 FLUMES
 TABLE
 CUSTOM

6.3.1.1.1 RECT. SUPPRESSED

For Rectangular Suppressed it's necessary to input the "L" dimension (width) of the weir (see fig.15)

▶ RECT. SUPPRESSED 3.1.1
 RECT. CONTRACTED
 TRAPEZOIDAL
 V NOTCH

To edit numbers, press **↑** to modify the digit shown in negative, press **↻** to edit the next digit. Press **OK** to confirm

SET DIMENSION 3.1.1.1
0000 mm

Fig.15 NO CONSTRICTION RECTANGULAR WEIR "Bazin"

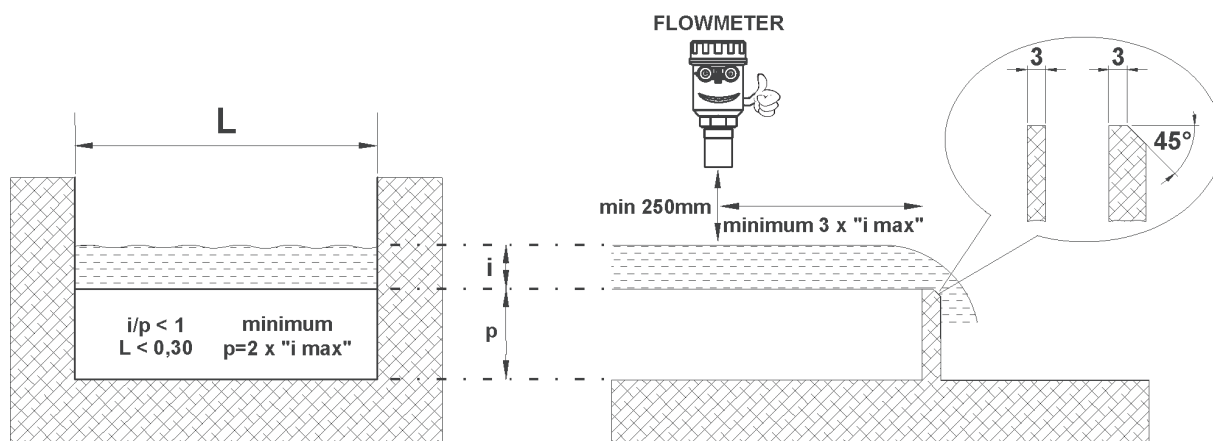

FLOWMETER - Configuration

6.3.1.1.1 RECT. CONTRACTED

For Rectangular Suppressed it's necessary to input the "L" dimension (width) of the weir (see fig.16)

To edit numbers, press to modify the digit shown in negative, press to edit the next digit. Press to confirm

- RECT. SUPPRESSED 3.1.1
- ▶ RECT. CONTRACTED
- TRAPEZOIDAL
- V NOTCH

3.1.1.1
SET DIMENSION

0000 mm

Fig.16

CONSTRICION RECTANGULAR WEIR "Francis"

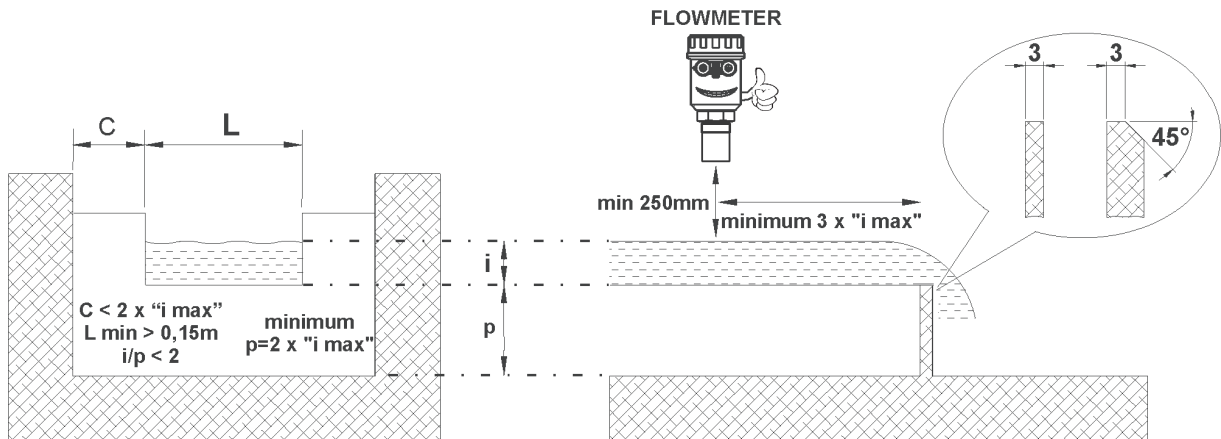

6.3.1.1.1 TRAPEZOIDAL

For Rectangular Suppressed it's necessary to input the "L" dimension (width) of the weir (see fig.17)

To edit numbers, press to modify the digit shown in negative, press to edit the next digit. Press to confirm

- RECT. SUPPRESSED 3.1.1
- RECT. CONTRACTED
- ▶ TRAPEZOIDAL
- V NOTCH

3.1.1.1
SET DIMENSION

0000 mm

Fig.17

TRAPEZOIDAL OR CIPOLETTI WEIR

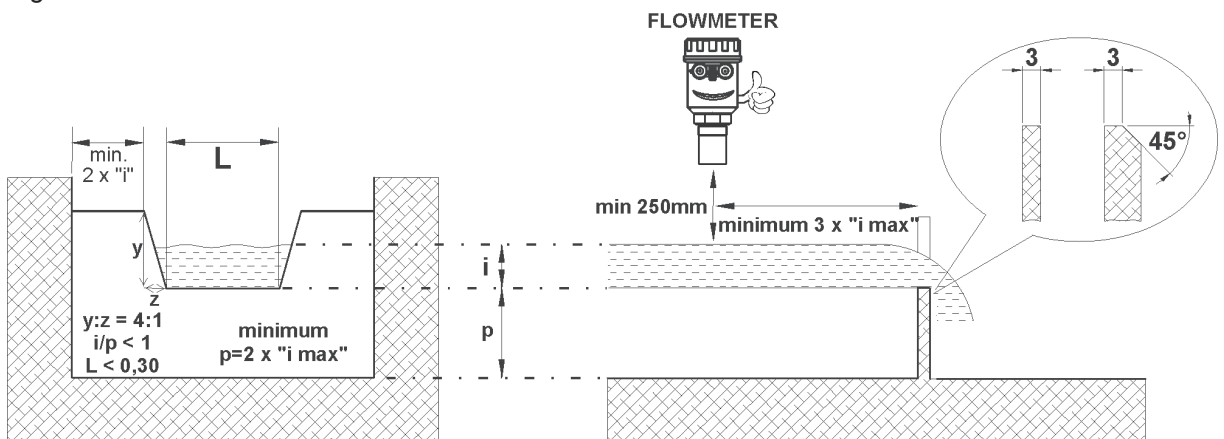

FLOWMETER - Configuration

6.3.1.1.1 V NOTCH

For Rectangular Suppressed it's necessary to input the "E" angle (in degree) of the weir (see fig.18)

To edit numbers, press **↑** to modify the digit shown in negative, press **↶** to edit the next digit.

Press **OK** to confirm

RECT. SUPPRESSED 3.1.1
 RECT. CONTRACTED
 TRAPEZOIDAL
 ▶ V NOTCH

SET ANGLE ° 3.1.1.2

000.0

Fig.18

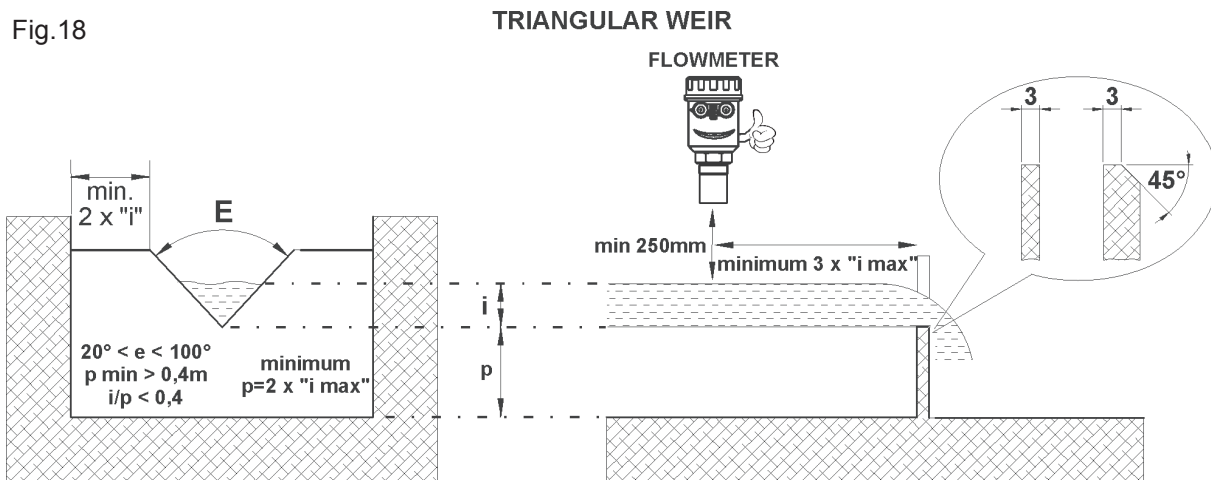

6.3.1.2 FLUMES

It's possible to choose which flume is used

WEIRS 3.1
 ▶ FLUMES
 TABLE
 CUSTOM

6.3.1.2.1 SGM VENTURI STD

Select the SGM LEKTRA venturi model installed (see fig.19)

Select by moving the cursor with **↶** and confirm with **OK**.

▶ SGM VENTURI STD 3.1.2
 SGM VENTURI
 KAFAGI VENTURI
 PARSHALL INCH
 PARSHALL FEET

Fig.19



▶ BS 150 3.1.2.1
 BS 200
 BS 300
 BS 400
 BS 500
 BS 600
 BS 800
 BS 1000

FLOWMETER - Configuration

6.3.1.2.2 SGM VENTURI

For SGM Venturi it's necessary to input the "L" dimension (width) of the flume (see fig.20)

To edit numbers, press **↑** to modify the digit shown in negative, press **↶** to edit the next digit. Press **OK** to confirm

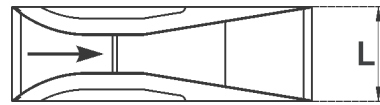

Fig.20

- 3.1.2
- SGM VENTURI STD
 - ▶ SGM VENTURI
 - KAFAGI VENTURI
 - PARSHALL INCH
 - PARSHALL FEET

3.1.2.2

SET DIMENSION

0000 mm

6.3.1.2.3 KAFAGI VENTURI

For KAFAGI Venturi it's necessary to input the "L" dimension (width) of the flume (see fig.21)

To edit numbers, press **↑** to modify the digit shown in negative, press **↶** to edit the next digit. Press **OK** to confirm



Fig.21

- 3.1.2
- SGM VENTURI STD
 - SGM VENTURI
 - ▶ KAFAGI VENTURI
 - PARSHALL INCH
 - PARSHALL FEET

3.1.2.2

SET DIMENSION

0000 mm

6.3.1.2.4 PARSHALL INCH

For PARSHALL INCH it's necessary to select the (L) dimension (width) of the flume (see fig.22)

Select by moving the cursor with **↶** and confirm with **OK**.

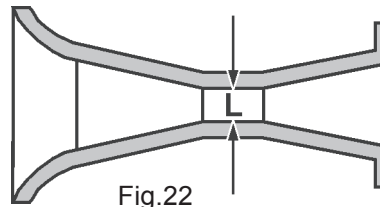

Fig.22

- 3.1.2
- SGM VENTURI STD
 - SGM VENTURI
 - KAFAGI VENTURI
 - ▶ PARSHALL INCH
 - PARSHALL FEET

- 3.1.2.3
- ▶ 1 inch
 - 2 inch
 - 3 inch
 - 6 inch
 - 9 inch
 - 12 inch (1 ft)
 - 18 inch (1.5 ft)

6.3.1.2.5 PARSHALL FEET

For PARSHALL FEET it's necessary to select the "L" dimension (width) of the flume (see fig.23)

Select by moving the cursor with **↶** and confirm with **OK**.

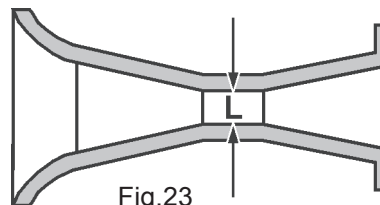

Fig.23

- 3.1.2
- SGM VENTURI STD
 - SGM VENTURI
 - KAFAGI VENTURI
 - PARSHALL INCH
 - ▶ PARSHALL FEET

- 3.1.2.4
- ▶ 1 ft
 - 2 ft
 - 3 ft
 - 6 ft
 - 9 ft
 - 12 ft
 - 18 ft

FLOWMETER - Configuration

6.3.1.3 TABLE

The flow is calculated by using a table that is stored in the system memory. the table setting is available only with the communication program MUDBUS.

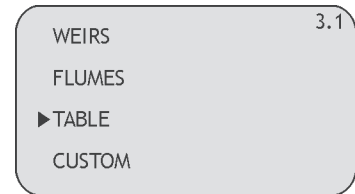

6.3.1.4 CUSTOM

the flow is calculated by using 4 parameter that are stored in the system memory. It's possible to see those parameters.
The parameters setting is available only with the MUDBUS communication program

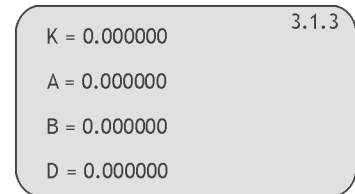
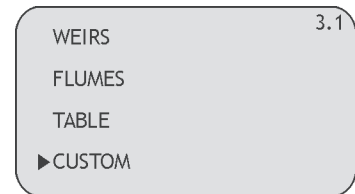

6.3.2 SELF CALIBRATION

it's possible to input the actual head measured; the system will automatically find the "0" head (level) which correspond to a 4mA analog output (minimum flow).

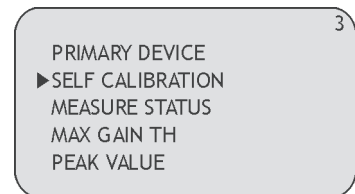

To edit numbers, press to modify the digit shown in negative, press to edit the next digit. Press to confirm.

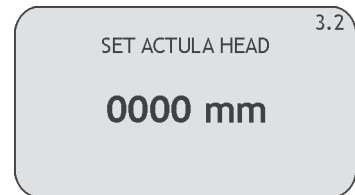

6.3.3 MEASURE STATUS

it's possible to display the gain of the system, with values from 0 to 255. While displayed, the automatic gain control is not active.

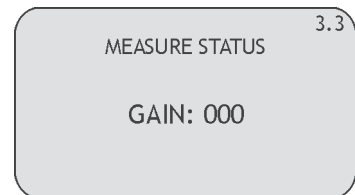
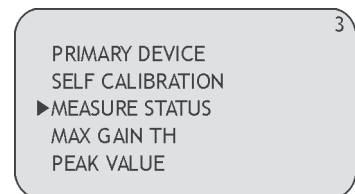

6.3.4 MAX GAIN TH

it's possible to input a value of gain that it should be not reached. If the gain is above this value, an error occurs.

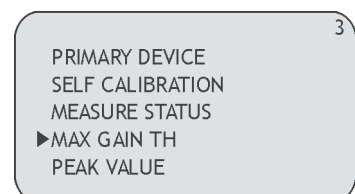

To edit numbers, press to modify the digit shown in negative, press to edit the next digit. Press to confirm.

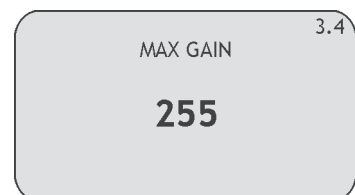

6.3.5 PEAK VALUE

the system store the maximum flow and the minimum flow measured since the power is turned ON. It's possible to see those values or reset them

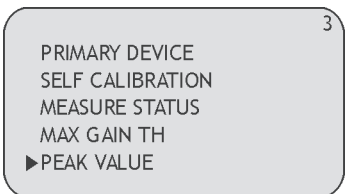

6.3.5.1 DISPLAY VALUE

In this submenu you can view the low and high flowrate reading peaks

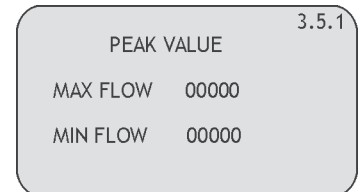

6.3.5.2 RESET VALUE

Select RESET VALUE by moving the cursor with and confirm with



6.4 SERVICE (4)

From "RUN" mode, press then move the cursor on "SERVICE" and confirm with

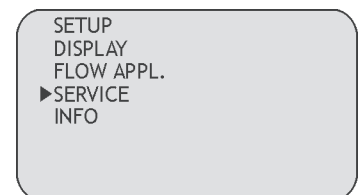

6.4.1 OUTPUT SAVE MODE

it's possible to choose a value of analog output durin condition of system's internal errors. Hold last value keep the output at the level corresponding at last valid measure.

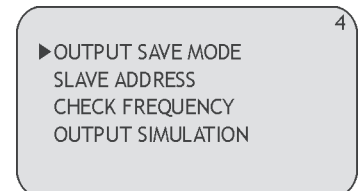

Select RESET VALUE by moving the cursor with and confirm with

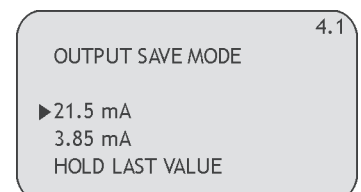

6.4.2 SLAVE ADDRESS

it's possible to input the UID of the instrument, in order to properly communicate with a MODBUS master

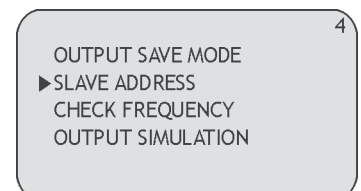

To edit numbers, press to modify the digit shown in negative, press to edit the next digit. Press to confirm.



6.4.3 CHECK FREQUENCY

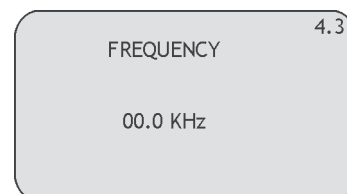
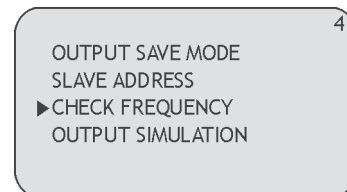

It's possible to check the computed emission frequency of the sensor

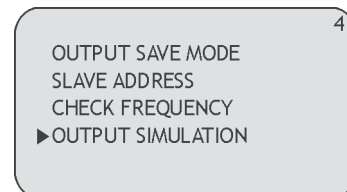

6.4.4 OUTPUT SIMULATION

It's possible to force the analog output to a desired value



To edit numbers, press  to modify the digit shown in negative, press  to edit the next digit. Press  to confirm.

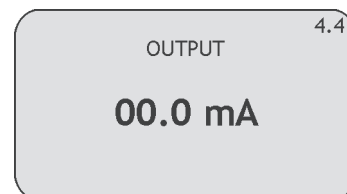

6.4 INFO (5)

From "RUN" mode, press **OK** then move the cursor on "INFO" and confirm with **OK**
Informations about manufacturer, firmware version and serial number are displayed

SETUP
DISPLAY
FLOW APPL.
SERVICE
▶ INFO

FLOWMETER REV. 0.00⁵
IC 1.1.01

WWW.SGM-LEKTRA.COM

FLOWMETER - Warranty

Products supplied by GESINT SRL are guaranteed for a period of 12 (twelve) months from delivery date according to the conditions specified in our sale conditions document.

GESINT SRL can choose to repair or replace the Product.

If the Product is repaired it will maintain the original term of guarantee, whereas if the Product is replaced it will have 12 (twelve) months of guarantee.

The warranty will be null if the Client modifies, repair or uses the Products for other purposes than the normal conditions foreseen by instructions or Contract.

In no circumstances shall GESINT SRL be liable for direct, indirect or consequential or other loss or damage whether caused by negligence on the part of the company or its employees or otherwise howsoever arising out of defective goods

FLOWMETER - Factory Test Certificate

In conformity to the company and check procedures I certify that the equipment:

FLOWMETER Serial n.

is conform to the technical requirements on Technical Data and it is made in conformity to the procedure

Quality Control Manager

Production and check date



documentazione soggetta a variazioni tecniche senza preavviso



GESINT.

GESINT S.R.L.

Via Perosi, 5

20010 Bareggio (MI) - ITALY

Tel. 02/9014633 - 335/6282615

Fax 02/90362295

e-mail: info@gesintsrl.it

WWW.GESINTSRL.IT