

High-quality pressure transmitter For general industrial applications Model S-20

WIKA data sheet PE 81.61



Applications

- Critical industrial applications
- Demanding applications in research and development
- Harsh environments in the process industry

Special features

- Measuring ranges from 0 ... 0.4 to 0 ... 1,600 bar (0 ... 10 to 0 ... 20,000 psi)
- Non-linearity of up to 0.125 % of span
- Different output signals, e.g. 4 ... 20 mA, DC 0 ... 10 V, DC 1 ... 5 V and others
- Market-standard electrical connections, e.g. DIN EN 175301-803 A angular connector
- Common international process connections



Pressure transmitter model S-20

Description

The model S-20 pressure transmitter for general industrial applications is the ideal solution for customers with demanding measuring requirements. It features a very good accuracy, a robust design and an exceptional number of variants, meaning it can be suited to the widest range of applications.

Versatile

The model S-20 offers continuous measuring ranges between 0 ... 0.4 and 0 ... 1,600 bar (0 ... 10 to 0 ... 20,000 psi) in all the major units.

These measuring ranges can be combined in almost any way with all the standard industry output signals, the most common international process connections and a wide number of electrical connections.

Furthermore, it offers numerous options, such as different accuracy classes, extended temperature ranges and customer-specific pin assignments.

High quality

The robust design turns the model S-20 into a very high quality product, which even the most adverse environmental conditions cannot affect. Whether with the lowest temperatures when used outdoors, with extreme shock and vibration in machine building or with aggressive media in the chemical industry, this transmitter can meet all requirements.

Availability

All variants described in this data sheet are available on very short lead times. For particularly urgent demands, there is a sizeable stock available.

Measuring ranges

Gauge pressure							
bar	0 ... 0.4	0 ... 0.6	0 ... 1	0 ... 1.6	0 ... 2.5	0 ... 4	0 ... 6
	0 ... 10	0 ... 16	0 ... 25	0 ... 40	0 ... 60	0 ... 100	0 ... 160
	0 ... 250	0 ... 400	0 ... 600	0 ... 1,000	0 ... 1,600		
psi	0 ... 10	0 ... 15	0 ... 25	0 ... 30	0 ... 50	0 ... 60	0 ... 100
	0 ... 150	0 ... 160	0 ... 200	0 ... 250	0 ... 300	0 ... 400	0 ... 500
	0 ... 600	0 ... 750	0 ... 1,000	0 ... 1,500	0 ... 2,000	0 ... 3,000	0 ... 4,000
	0 ... 5,000	0 ... 6,000	0 ... 7,500	0 ... 10,000	0 ... 15,000	0 ... 20,000	

Absolute pressure							
bar	0 ... 0.4	0 ... 0.6	0 ... 1	0 ... 1.6	0 ... 2.5	0 ... 4	0 ... 6
	0 ... 10	0 ... 16	0 ... 25	0 ... 40			
psi	0 ... 10	0 ... 15	0 ... 25	0 ... 30	0 ... 50	0 ... 60	0 ... 100
	0 ... 150	0 ... 160	0 ... 200	0 ... 250	0 ... 300	0 ... 400	0 ... 500

Vacuum and +/- measuring range					
bar	-0.4 ... 0	-0.6 ... 0	-1 ... 0	-1 ... +0.6	-1 ... +1.5
	-1 ... +3	-1 ... +5	-1 ... +9	-1 ... +15	-1 ... +24
	-1 ... +39	-1 ... +59			
psi	-30 inHg ... 0	-30 inHg ... +15	-30 inHg ... +30	-30 inHg ... +45	-30 inHg ... +60
	-30 inHg ... +100	-30 inHg ... +160	-30 inHg ... +200	-30 inHg ... +300	-30 inHg ... +500

The given measuring ranges are also available in kg/cm², kPa and MPa.

Special measuring ranges between 0 ... 0.4 and 0 ... 1,600 bar (0 ... 10 bis 0 ... 20,000 psi) are available on request.

Special measuring ranges have a reduced long-term stability and increased temperature errors.

Overpressure limit

The overpressure limit is based on the sensor element used. Depending on the selected process connection and sealing, restrictions in overpressure safety can result.

A higher overpressure limit will result in a higher temperature error.

Available overpressure limits		
Measuring range	< 10 bar (150 psi)	≥ 10 bar (150 psi)
Standard	3 times	2 times ¹⁾
Option	5 times	3 times ^{2) 3)}

1) Restriction: max. 60 bar (870 psi) with absolute pressure

2) Only possible for gauge pressure measuring ranges ≤ 400 bar (5,800 psi)

3) Only possible for absolute pressure measuring ranges < 16 bar (220 psi)

Vacuum tightness

Yes

Reference conditions (per IEC 61298-1)

Temperature: 15 ... 25 °C (59 ... 77 °F)

Atmospheric pressure: 860 ... 1,060 mbar (12.5 ... 15.4 psi)

Humidity: 45 ... 75 % r. h.

Power supply: DC 24 V, DC 5 V with ratiometric output

Mounting position: Calibrated in vertical mounting position with pressure connection facing downwards.

Output signal

Available output signals	
Signal type	Signal
Current (2-wire)	4 ... 20 mA
	20 ... 4 mA
Voltage (3-wire)	DC 0 ... 10 V
	DC 0 ... 5 V
	DC 1 ... 5 V
	DC 0.5 ... 4.5 V
	DC 1 ... 6 V
DC 10 ... 0 V	
Ratiometric (3-wire)	DC 0.5 ... 4.5 V

Other output signals on request.

Permissible load in Ω

■ Current output (2-wire)

\leq (power supply - 7.5 V) / 0.023 A

with optional settling time of 1 ms:
 \leq (power supply - 11.5 V) / 0.023 A

■ Voltage output (3-wire)

> maximum output voltage / 1 mA

■ Ratiometric output (3-wire):

> 4.5k

Signal limiting (option)

4 ... 20 mA: Zero point: 3.6 mA⁴⁾ / 3.8 mA / 4.0 mA
 Full scale: 20 mA / 21.5 mA / 23 mA

DC 0 ... 10 V: Full scale: DC 10 V / DC 11.5 V

4) Not possible in combination with zero point adjustment by the customer

Voltage supply

Power supply

Maximum power supply for cULus approval: DC 35 V (DC 32 V with heavy-duty connector)

■ Current output (2-wire)

4 ... 20 mA: DC 8 ... 36 V (DC 12 ... 36 V with optional settling time of 1 ms)

20 ... 4 mA: DC 8 ... 36 V

■ Voltage output (3-wire)

DC 0 ... 10 V: DC 12 ... 36 V

DC 0 ... 5 V: DC 8 ... 36 V

DC 1 ... 5 V: DC 8 ... 36 V

DC 0.5 ... 4.5 V: DC 8 ... 36 V

DC 1 ... 6 V: DC 9 ... 36 V

DC 10 ... 0 V: DC 12 ... 36 V

■ Ratiometric output (3-wire):

DC 0.5 ... 4.5 V: DC 5 V \pm 10 %

Dissipation loss

■ Current output (2-wire)

828 mW (22 mW/K derating of the dissipation loss with ambient temperatures \geq 100 °C (212 °F))

■ Voltage output (3-wire)

432 mW

Current supply

Current output (2-wire): Current signal, max. 25 mA

Voltage output (3-wire): max. 12 mA

Time response

Signal type	Settling time per IEC 62594		Signal damping
	Standard ⁵⁾	Option 1 ^{6) 7)}	Option 2
Current (2-wire)	3 ms	1 ms	10 / 50 / 100 / 500 / 1,000 / 5,000 ms
Voltage (3-wire)	2 ms	1 ms	10 / 50 / 100 / 500 / 1,000 / 5,000 ms
Ratiometric (3-wire)	2 ms	1 ms	10 / 50 / 100 / 500 / 1,000 / 5,000 ms

5) 3 dB limit frequency: 500 Hz

6) 3 dB limit frequency: 1,000 Hz

7) Alternative specifications for 4 ... 20 mA output signal:

Load: \leq (power supply - 11.5 V) / 0.023 A

Power supply: DC 12 ... 36 V

Switch-on time

150 ms

Switch-on drift

5 s (60 s with optional zero point adjustment 0.1 %)

Accuracy data

	Non-linearity (per IEC 61298-2)		Accuracy at calibration temperature
	BFSL	Terminal method	
Standard	$\leq \pm 0.25$ % of span	$\leq \pm 0.5$ % of span	$\leq \pm 0.5$ % of span
Option 1	$\leq \pm 0.5$ % of span	$\leq \pm 1.0$ % of span	$\leq \pm 1.0$ % of span
Option 2	$\leq \pm 0.125$ % of span ⁸⁾	$\leq \pm 0.25$ % of span ⁸⁾	$\leq \pm 0.25$ % of span ⁸⁾

8) Restrictions for the non-linearity of 0.125 % BFSL or 0.25 % with terminal method:
 Available output signals: 4 ...20 mA and DC 0 ... 10 V
 Available measuring ranges: All measuring ranges specified in the data sheet
 For further output signals or measuring ranges, please ask the manufacturer

Calibration temperature		
Standard	15 ... 25 °C	(59 ... 77 °F)
Option 1	4 °C \pm 5 °C	(39.2 °F \pm 41 °F)
Option 2	40 °C \pm 5 °C	(104 °F \pm 41 °F)
Option 3	60 °C \pm 5 °C	(140 °F \pm 41 °F)
Option 4	80 °C \pm 5 °C	(176 °F \pm 41 °F)

Zero point adjustment	
Standard	$\leq \pm 0.2$ % of span, factory setting
Option 1	$\leq \pm 0.1$ % of span, factory setting ⁹⁾
Option 2	± 10 % of span, customer setting ¹⁰⁾ (stepwise 0.05 %)

9) Restrictions for the zero point adjustment of 0.1% (factory setting):
 Available output signals: 4 ...20 mA and DC 0 ... 10 V
 Available measuring ranges: All relative pressure measuring ranges specified in the data sheet
 Not available in combination with optional calibration temperatures.

10) The customer zero point adjustment is not available for all variants of electrical connection, see "Electrical connections".

Relationship to the mounting position

For measuring ranges < 1 bar (15 psi), an additional zero offset of up to 0.15 % applies

Non-repeatability

$\leq \pm 0.1$ % of span

Temperature hysteresis

0.1 % of span at > 80 °C (176 °F)

Long-term drift (per IEC 61298-2)

■ $\leq \pm 0.1$ % of span

■ $\leq \pm 0.2$ % of span (with special measuring ranges and measuring ranges < 1 bar (15 psi))

Temperature error (for calibration temperature 15 ... 25 °C (59 ... 77°F))

For measuring ranges < 1 bar (15 psi), special measuring ranges and instruments with an increased overpressure limit the respective temperature error increases by 0.5 % of span

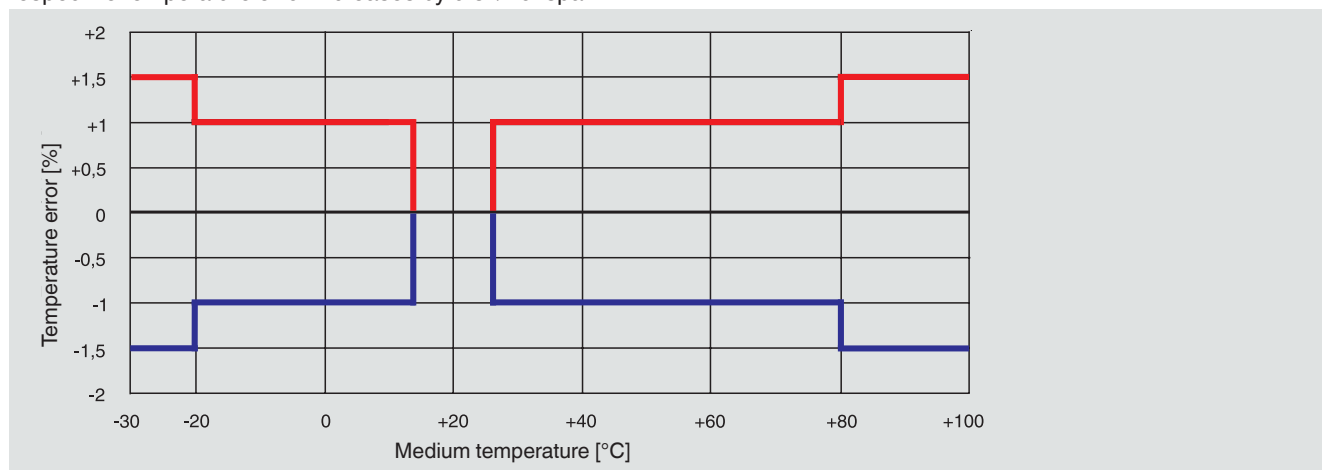

Operating conditions

Permissible temperature ranges

	Medium	Ambient	Design	max. permissible pressure
Standard	-30 ... +100 °C (-22 ... +212 °F)	-30 ... +100 °C (-22 ... +212 °F)	-	-
Option 1	-40 ... +125 °C (-40 ... +257 °F)	-40 ... +125 °C (-40 ... +257 °F)	-	-
Option 2	-40 ... +150 °C (-40 ... +302 °F)	-40 ... +125 °C (-40 ... +257 °F) ¹¹⁾	with integrated cooling element	400 bar (5,800 psi)
Option 3	-40 ... +200 °C (-40 ... +392 °F)	-40 ... +125 °C (-40 ... +257 °F) ¹¹⁾	with integrated cooling element	400 bar (5,800 psi)
Option 4	-20 ... +60 °C (-4 ... +140 °F)	-20 ... +60 °C (-4 ... +140 °F)	Oxygen application	-
Option 5	-20 ... +80 °C (-4 ... +176 °F)	-20 ... +80 °C (-4 ... +176 °F)	Performance level	-

11) Derating curve and formula (see following diagram)

Depending on the choice of sealing on the process connection and the electrical connection, there may be limitations in the medium and the ambient temperatures (for restrictions see "Process connections, sealings" and "Electrical connections").

Derating curve for cooling elements

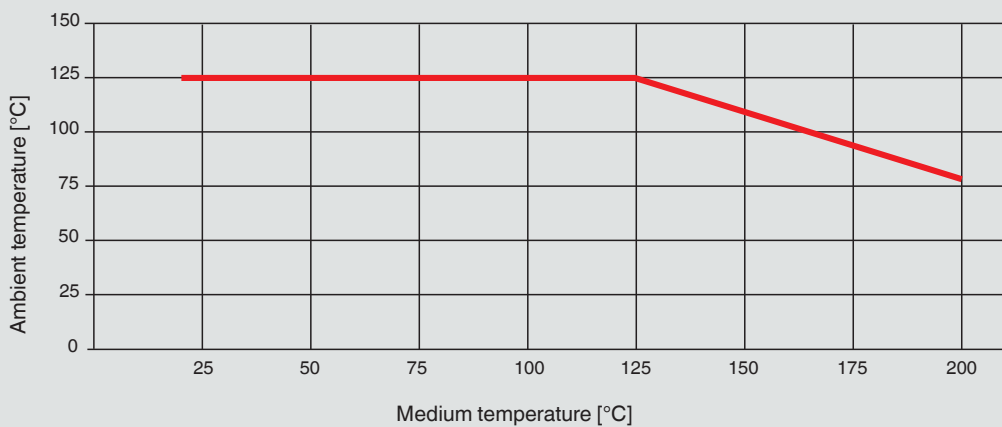

Maximum permissible ambient temperature

$$T_{amb} (T_{med} < 125 \text{ °C}) = 125 \text{ °C}$$

$$T_{amb} (T_{med} \geq 125 \text{ °C}) = -0.62 \times T_{med} + 202 \text{ °C}$$

T_{amb} = Ambient temperature [°C]
 T_{med} = Medium temperature [°C]

Maximum permissible medium temperature

$$T_{med} (T_{amb} < 80 \text{ °C}) = 200 \text{ °C}$$

$$T_{med} (T_{amb} \geq 80 \text{ °C}) = -1.61 \times T_{amb} + 326 \text{ °C}$$

Storage and transport conditions

Permissible temperature range: -40 ... +70 °C (-40 ... +158 °F)

Maximum humidity (per IEC 68-2-78):

67 % r. h. at 40 °C (104 °F) (in accordance with 4K4H per EN 60721-3-4)

Climate class

Storage: 1K3 (per EN 60721-3-1)

Transport: 2K3 (per EN 60721-3-2)

Operation: 4K4H (per EN 60721-3-4, without condensation or icing)

Vibration resistance (per EC 60068-2-6)

20 g, 10 ... 2,000 Hz

(40 g, 10 ... 2,000 Hz for circular connector M12 x 1, metallic)

For instruments with cooling elements a limited vibration resistance of 10 g, 10 ... 2,000 Hz, applies

Continuous vibration resistance (per IEC 60068-2-6)

10 g

Shock resistance (per EC 60068-2-27)

100 g, 6 ms

500 g, 1 ms for circular connector M12 x 1, metallic

EM field

30 V/m (80 ... 1,000 Mhz)

Service life

100 million load cycles (10 million load cycles for measuring ranges > 600 bar/7,500 psi)

Free-fall test (following IEC 60721-3-2)

Individual packaging: 1.5 m (5 ft)

Multiple packaging: 0.5 m (1.6 ft)

PE bag: 0.5 m (1.6 ft)

Process connections

Available connections

Process connection per	Thread size	Maximum overpressure limit	Optional pressure port ¹³⁾
EN 837	G 1/8 B	800 bar (11,600 psi)	
	G 1/4 B ¹²⁾	1,400 bar (20,300 psi)	0.3 mm / 0.6 mm / 6 mm ¹⁴⁾ (0.01 in / 0.02 in / 0.24 in ¹⁴⁾)
	G 1/4 female	1,400 bar (20,300 psi)	
	G 1/2 B ¹²⁾	1,800 bar (26,100 psi) (1.4404) 3,200 bar (46,400 psi) (1.4542)	0.3 mm / 0.6 mm (0.01 in / 0.02 in)
	G 3/8 B	1,400 bar (20,300 psi)	
DIN 3852-E	G 1/4 A ¹²⁾	600 bar (8,700 psi)	0.3 mm / 0.6 mm (0.01 in / 0.02 in)
	G 1/2 A	600 bar (8,700 psi)	0.3 mm / 0.6 mm / 12 mm ¹⁴⁾ (0.01 in / 0.02 in / 0.48 in ¹⁴⁾)
	M14 x 1.5	600 bar (8,700 psi)	
DIN 16288	M20 x 1.5	1,800 bar (1.4404) 3,300 bar (1.4542)	
	M12 x 1.5	1,400 bar (20,300 psi)	
SAE J514 E	7/16-20 UNF BOSS	600 bar (8,700 psi)	0.3 mm / 0.6 mm / 6 mm ¹⁴⁾ (0.01 in / 0.02 in / 0.24 in ¹⁴⁾)
	7/16-20 UNF J514 sealing cone 74°	1,100 bar (15,900 psi)	
	9/16-18 UNF BOSS	600 bar (8,700 psi)	
ANSI/ASME B1.20.1	1/8 NPT	1,100 bar (15,900 psi)	
	1/4 NPT	1,500 bar (21,700 psi)	0.3 mm / 0.6 mm / 6 mm ¹⁴⁾ (0.01 in / 0.02 in / 0.24 in ¹⁴⁾)
	1/4 NPT female	1,500 bar (21,700 psi)	
	1/2 NPT ¹²⁾	1,500 bar (21,700 psi) (1.4404) 2,800 bar (40,600 psi) (1.4542)	0.3 mm / 0.6 mm / 12 mm ¹⁴⁾ (0.01 in / 0.02 in / 0.48 in ¹⁴⁾)
KS	PT 1/4	1,600 bar (23,200 psi)	0.3 mm / 0.6 mm / 6 mm ¹⁴⁾ (0.01 in / 0.02 in / 0.24 in ¹⁴⁾)
	PT 1/2	1,500 bar (21,700 psi)	
	PT 3/8	1,400 bar (20,300 psi)	
ISO 7	R 1/4 ¹²⁾	1,600 bar (23,200 psi)	0.3 mm / 0.6 mm / 6 mm ¹⁴⁾ (0.01 in / 0.02 in / 0.24 in ¹⁴⁾)
	R 3/8	1,500 bar (21,700 psi)	
	R 1/2	1,400 bar (20,300 psi) (1.4404) 2,840 bar (41,200 psi) (1.4542)	

¹²⁾ For medium temperatures up to 150 °C (302 °F) or 200 °C (392 °F) available with cooling element.

¹³⁾ Pressure port 2.5 mm as standard

¹⁴⁾ Wider pressure port with 6 mm (0.24 in) or 12 mm (0.48 in) only feasible for measuring ranges up to and including 0...40 bar (0...500 psi).

Other process connections on request.

Sealings

Process connection per	Copper -40 ... +125 °C (-40 ... +257 °F)	Stainless steel -40 ... +125 °C (-40 ... +257 °F)	NBR -20 ... +100 °C (-4 ... +212 °F)	FKM -15 ... +125 °C (-5 ... +257 °F)	FPM -15 ... +200 °C (-5 ... +392 °F)
EN 837	Standard	Option	-	-	
DIN 3852-E	-	-	Standard	Option	Option
DIN 16288	Standard	Option	-	-	
SAE J514 E	-	-	Standard	Option	

Electrical connections

Available connections

Electrical connection	Ingress protection ¹⁶⁾	Wire cross-section	Cable Ø	Cable material	Permissible temperature
Angular connector DIN EN 175301-803 A ¹⁵⁾					
with mating connector	IP 65	max. 1.5 mm ²	6 ... 8 mm	-	-30 ... +100 °C (-22 ... +212 °F)
with mating connector (conduit)	IP 65	max. 1.5 mm ²	-	-	-30 ... +100 °C (-22 ... +212 °F)
with mating connector with moulded cable	IP 65	3 x 0.75 mm ²	6 mm	PUR	-30 ... +100 °C (cULus: -25 ... +85 °C) (-22 ... +212 °F (cULus: -4 ... +185 °F))
with mating connector with moulded cable, shielded	IP 65	6 x 0.5 mm ²	6.8 mm	PUR	-25 ... +85 °C (-4 ... +185 °F)
Angular connector DIN EN 175301-803 C ¹⁵⁾					
with mating connector	IP 65	max. 0.75 mm ²	4.5 ... 6 mm	-	-30 ... +100 °C (-22 ... +212 °F)
with mating connector with moulded cable	IP 65	4 x 0.5 mm ²	6.2 mm	PUR	-25 ... +85 °C (-4 ... +185 °F)
Circular connector M12 x 1 (4-pin) ¹⁵⁾					
without mating connector	IP 67	-	-	-	-30 ... +100 °C (-22 ... +212 °F)
with mating connector, straight, with moulded cable	IP 67	3 x 0.34 mm ²	4.3 mm	PUR	-25 ... +80 °C (-4 ... +176 °F)
with mating connector, straight, with moulded cable, shielded	IP 67	3 x 0.34 mm ²	4.3 mm	PUR	-25 ... +80 °C (-4 ... +176 °F)
with mating connector, angled, with moulded cable	IP 67	3 x 0.34 mm ²	5.5 mm	PUR	-25 ... +80 °C (-4 ... +176 °F)
Circular connector M12 x 1 (4-pin, metallic)					
without mating connector	IP 67	-	-	-	-40 ... +125 °C (cULus: +85 °C) (-40 ... +257 °F (cULus: +185 °F))
with mating connector, straight, with moulded cable	IP 67	3 x 0.34 mm ²	4.3 mm	PUR	-25 ... +80 °C (-4 ... +176 °F)
with mating connector, straight, with moulded cable, shielded	IP 67	3 x 0.34 mm ²	4.3 mm	PUR	-25 ... +80 °C (-4 ... +176 °F)
with mating connector, angled, with moulded cable	IP 67	3 x 0.34 mm ²	5.5 mm	PUR	-25 ... +80 °C (-4 ... +176 °F)
Bayonet connector (6-pin)					
	IP 67	-	-	-	-40 ... +125 °C (-40 ... +257 °F)
Field case					
	IP 6K9K	-	7 ... 13 mm	-	-25 ... +100 °C (-4 ... +212 °F)
Cable outlet					
Cable outlet IP 67 ¹⁵⁾	IP 67	3 x 0.34 mm ²	5.5 mm	PUR	-30 ... +100 °C (-22 ... +212 °F)
Cable outlet ½ NPT conduit	IP 67	6 x 0.35 mm ²	6.1 mm	PUR	-30 ... +100 °C (cULus: +90 °C) (-22 ... +212 °F (cULus: +194 °F))
Cable outlet IP 68	IP 68	6 x 0.35 mm ²	6.1 mm	PUR	-30 ... +125 °C (cULus: +90 °C) (-22 ... +257 °F (cULus: +194 °F))
Cable outlet IP 68, FEP	IP 68	6 x 0.39 mm ²	5.8 mm	FEP	-40 ... +125 °C (cULus: +105 °C) (-40 ... +257 °F (cULus: +221 °F))
Cable outlet IP 6K9K	IP 6K9K	6 x 0.35 mm ²	6.1 mm	PUR	-30 ... +125 °C (cULus: +90 °C) (-22 ... +257 °F (cULus: +194 °F))
Heavy-duty connector					
with mating connector with cable	IP 68	6 x 0.14 mm ²	6.5 mm	PUR	-40 ... +125 °C (cULus: -30 ... +90 °C) (-40 ... +257 °F (cULus: -22 ... +194 °F))

¹⁵⁾Customer zero point adjustment available as an option.

¹⁶⁾Only applies when plugged in using a suitable mating connector that has the appropriate ingress protection

Other connections on request.

Assembly configurations of the cable outlets

Electrical connection	Unfinished wire ends	Tinned wire ends	with end splices
Cable outlet IP 67	Standard	Option	Option
Cable outlet ½ NPT conduit	-	Option	Standard
Cable outlet IP 68	-	Option	Standard
Cable outlet IP 68, FEP	-	Option	Standard
Cable outlet IP 6K9K	-	Option	Standard

Cable lengths of 2 m, 5 m, 6 ft or 15 ft are available, further cable lengths on request.

Connection diagrams

Angular connector DIN 175301-803 A		2-wire	3-wire
	U+	1	1
	U-	2	2
	S+	-	3
	Shield (option)	4	4

Angular connector DIN 175301-803 C		2-wire	3-wire
	U+	1	1
	U-	2	2
	S+	-	3
	Shield (option)	4	4

Bayonet connector (6-pin)		2-wire	3-wire
	U+	A	A
	U-	B	B
	S+	-	C
	Shield	Case	Case

Cable outlet		2-wire	3-wire
	U+	brown (BN)	brown (BN)
	U-	blue (BU)	blue (BU)
	S+	-	black (BK)
	Shield ¹⁾	grey (GY)	grey (GY)

1) With cable outlet IP 67 and cable outlet ½ NPT conduit the shield is optional

Mating connector with moulded cable		2-wire	3-wire
	U+	brown (BN)	brown (BN)
	U-	blue (BU)	blue (BU)
	S+	-	black (BK)

Cable outlet (US code)		2-wire	3-wire
	U+	red (RD)	red (RD)
	U-	black (BK)	black (BK)
	S+	-	white (WH)
	Shield	grey (GY)	grey (GY)

Heavy-duty connector		2-wire	3-wire
	U+	1	1
	U-	2	2
	S+	-	3
	Shield	Case	Case

Circular connector M12 x 1 (4-pin)		2-wire	3-wire
	U+	1	1
	U-	3	3
	S+	-	4
	Shield (option)	Case	Case

Field case		2-wire	3-wire
	U+	1	1
	U-	2	2
	S+	-	3
	Shield	5	5

U+	Positive power supply terminal
U-	Negative power supply terminal
S+	Analogue output

Other pin assignments on request.

Electrical protective measures

The electrical protective measures are not valid for ratiometric output signals.

- Short-circuit resistance: S+ vs. U-
- Reverse polarity protection: U+ vs. U-
- Resistance to overvoltage: DC 40 V
- Insulation voltage: DC 750 V

Materials

Wetted parts

- Relative measuring ranges:
 - Measuring ranges ≤ 10 bar (150 psi): 316L
 - Measuring ranges > 10 bar (150 psi): 316L + 13-8 PH
 - Measuring ranges > 1,000 bar (10,000 psi): ASTM 630 and 13-8 PH
- Absolute pressure measuring ranges: 316L
- Sealing materials: See "Process connections"

Non-wetted parts

- Case: 316 Ti
- Zero point adjustment ring: PBT/PET GF30
- Electrical connections:
 - Angular connector DIN 175301-803 A: PBT/PET GF30
 - Angular connector DIN 175301-803 C: PBT/PET GF30
 - Circular connector M12 x 1 (4-pin): PBT/PET GF30
 - Circular connector M12 x 1 (4-pin, metallic): 316L
 - Bayonet connector (6-pin): 316L + Al
 - Field case: 316L, 316Ti
 - Heavy-duty connector: 316L
 - Cable outlet IP 67: PA66, PBT/PET GF30
 - Cable outlet ½ NPT conduit: 316L
 - Cable outlet IP 68: 316L
 - Cable outlet IP 68, FEP: 316L
 - Cable outlet IP 6K9K: 316L

Pressure transmission fluid

Synthetic oil (for measuring ranges < 10 bar (150 psi) gauge pressure, and all absolute pressure measuring ranges)

Options for specific media

Medium	Option
Food	Food-compatible transmission fluid
Oil and grease free	Residual hydrocarbon: < 1,000 mg/m ² Packaging: Protection cap on the process connection
Oxygen, oil and grease free	Residual hydrocarbon (measuring range < 30 bar (435 psi)): < 500 mg/m ² Residual hydrocarbon (measuring range > 30 bar (435 psi)): < 200 mg/m ² Packaging: Protection cap on the process connection, instrument sealed in a PE bag Maximum permissible temperature -20 ... +60 °C (-4 ... +140 °F) Elastomer sealing: Only FKM possible, max. -15 ... +60 °C (5 ... 140 °F) and max. 30 bar (435 psi) measuring range. Not possible with process connections with female thread
Hydrogen	On request Measuring ranges: from 25 bar (362 psi) gauge Wetted parts: 316L and Elgiloy® (2.4711) Maximum permissible temperature: -30 ... +30 °C (-22 ... +86 °F)

CE conformity

Pressure equipment directive
97/23/EC

EMC directive

2004/108/EC, EN 61326 emission (group 1, class B) and interference immunity (industrial application)

Manufacturer's declaration

RoHS conformity

2011/65/EU

Performance level (per EN ISO 13849-1:2008)

Performance level: PL = b
Category: Cat. = B
Diagnostic coverage: DC = none
MTTF: > 100 years
Operating temperature: -20 ... +80 °C
Further informations see safety manual on functional safety

Approvals

- **cULus**, Safety (e. g. electrical safety, overpressure, ...), USA
- **GOST-R**, import certificate, Russia
- **GOST**, metrology/measurement technology, Russia

Certificates (option)

Available certificates

2.2 test report

State-of-the-art manufacturing
Wetted metallic parts
Confirmation of the class and indication accuracy

3.1 inspection certificate

Wetted metallic parts
Wetted metallic parts with suppliers' certificate
Confirmation of the class and indication accuracy
List of single measured values

DKD/DAkkS calibration certificate

Approvals and certificates, see website

Scope of delivery

Test report

- Non-linearity 0.5 % 3 points
- Non-linearity 0.25 % 5 points
- Non-linearity 0.125 % 5 points

Packaging

Standard	Individual packaging
Option	Multiple packaging (up to 20 pieces)

Instrument labelling

Standard	WIKA label lasered
Option	Customer-specific label on request

Dimensions

Pressure transmitter model S-20

with angular connector DIN EN 175301-803 A

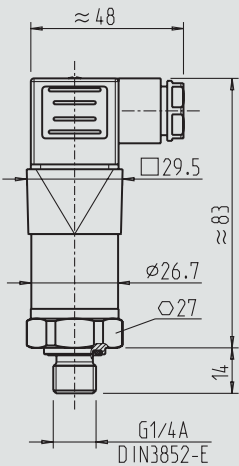

Dimensions in mm

Weight: approx. 150 g (0.331 lbs)

with angular connector DIN EN 175301-803 C

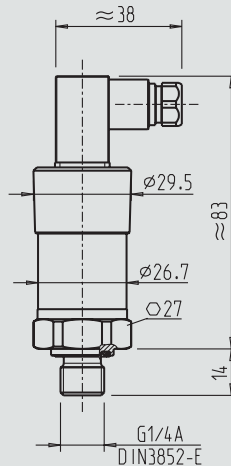

Dimensions in mm

Weight: approx. 150 g (0.331 lbs)

with bayonet connector (6-pin)

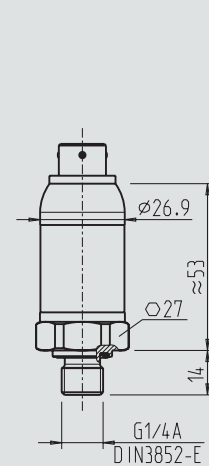

Dimensions in mm

Weight: approx. 150 g (0.331 lbs)

with circular connector M12 x 1 (4-pin)

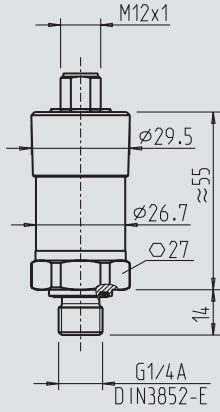

Dimensions in mm

Weight: approx. 150 g (0.331 lbs)

with M12 x 1 circular connector (4-pin, metallic)

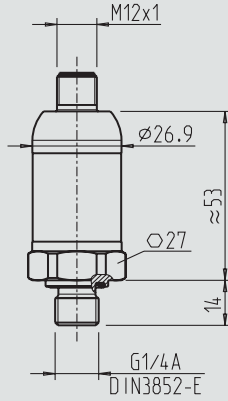

Dimensions in mm

Weight: approx. 150 g (0.331 lbs)

with heavy-duty connector

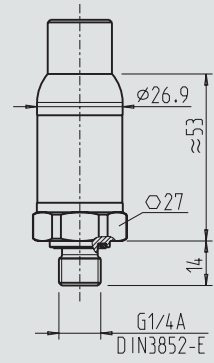

Dimensions in mm

Weight: approx. 150 g (0.331 lbs)

with field case

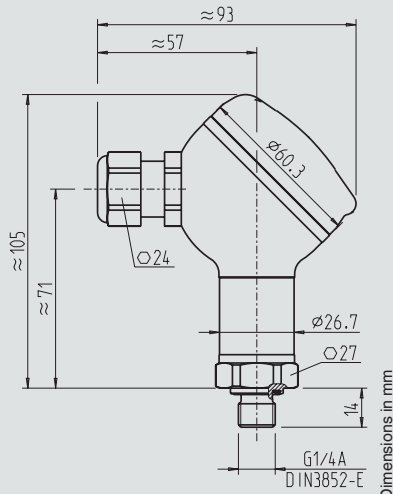

Dimensions in mm

Weight: approx. 290 g (0.639 lbs)

with cable outlet IP 68, FEP, IP 6K9K

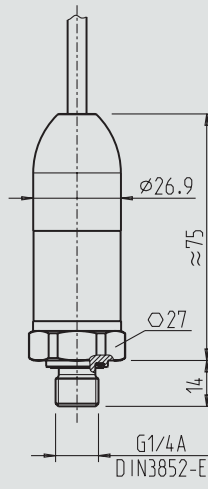

Dimensions in mm

Weight: approx. 220 g (0.485 lbs)

with cable outlet 1/2 NPT conduit

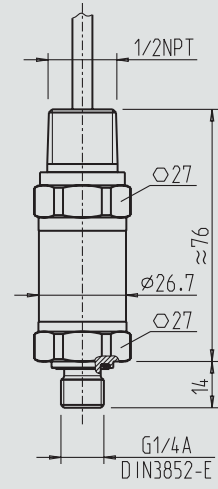

Dimensions in mm

Weight: approx. 220 g (0.485 lbs)

with angular connector DIN 175301-803 A and cooling element

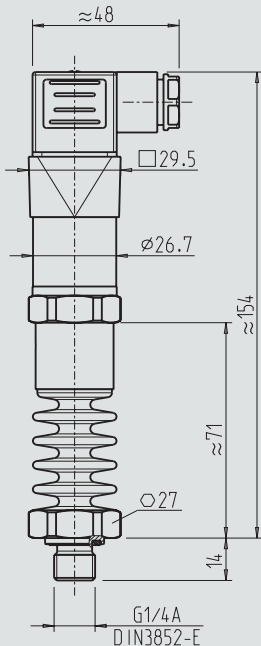

Dimensions in mm

Weight: approx. 360 g (0.794 lbs)

with cable outlet IP 67

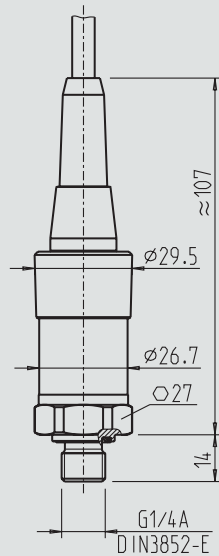

Dimensions in mm

Weight: approx. 150 g (0.331 lbs)

with angular connector DIN 175301-803 A and zero point adjustment

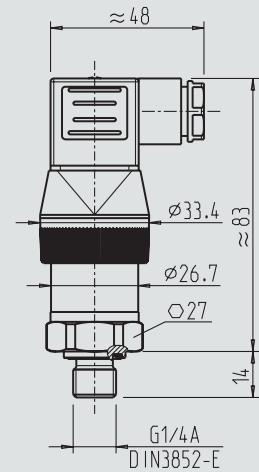

Dimensions in mm

Weight: approx. 150 g (0.331 lbs)

Process connections

Dimensions in mm (inch)

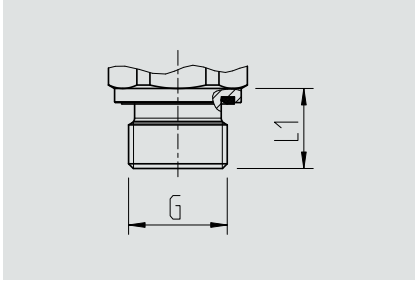

G	L1
G ¼ A	14 (0.55)
G ½ A	17 (0.67)
M14 x 1.5	14 (0.55)

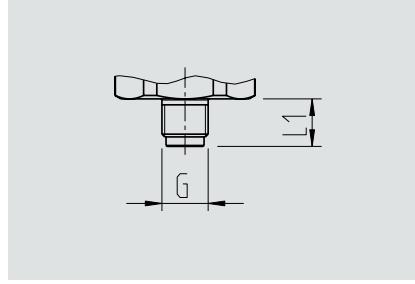

G	L1
G ⅛ B	10 (0.39)

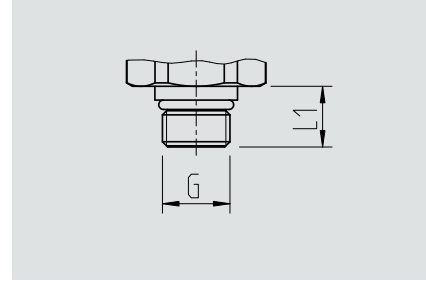

G	L1
7/16-20 UNF BOSS	12.06 (0.47)
9/16-18 UNF BOSS	12.85 (0.51)

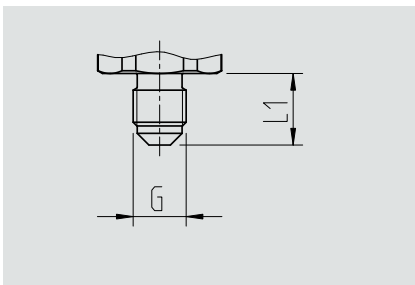

G	L1
7/16-20 UNF J514 sealing cone 74°	15 (0.59)

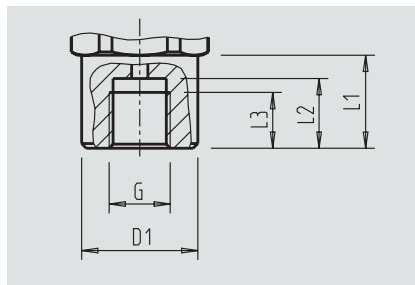

G	D1	L1	L2	L3
G ¼ female	25 (0.95)	20 (0.79)	13 (0.51)	10 (0.39)

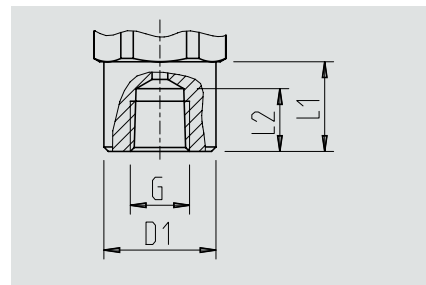

G	D1	L1	L2
¼ NPT female	25 (0.98)	20 (0.79)	14 (0.55)

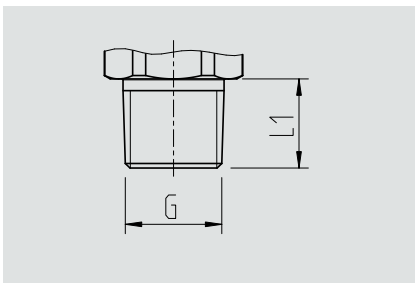

G	L1
⅛ NPT	10 (0.39)
¼ NPT	13 (0.51)
½ NPT	19 (0.75)
PT ¼	13 (0.51)
PT ½	19 (0.75)
PT ¾	15 (0.59)
R ¼	13 (0.51)
R ½	19 (0.75)
R ¾	15 (0.59)

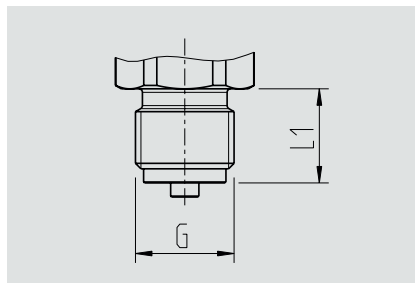

G	L1
G ¼ B	13 (0.51)
G ½ B	20 (0.79)
G ¾ B	16 (0.63)
M12 x 1.5	15 (0.59)
M20 x 1.5	20 (0.79)

For information on tapped holes and welding sockets, see Technical information IN 00.14 at www.wika.com.

Accessories and spare parts

Mating connector

Designation	Order no.			
	without cable	with 2 m (6 ft) cable	with 5 m (16 ft) cable	with 2 m (6 ft) cable, shielded
Angular connector DIN EN 175301-803 A				
■ with cable gland, metric	11427567	11225793	11250186	14100465
■ with cable gland, conduit	11022485	-	-	-
Angular connector DIN EN 175301-803 C	1439081	11225823	11250194	-
Circular connector M12 x 1 (4-pin)				
■ straight	-	11250780	11250259	14056584
■ angled	-	11250798	11250232	-

Sealings for mating connectors

Mating connector	Order no.	
	Blue (WIKA)	Brown (neutral)
Angular connector DIN EN 175301-803 A	1576240	11437902
Angular connector DIN 175301-803 C	11169479	11437881

Sealings for process connection

Thread size	Order no.				
	Copper	Stainless steel	NBR	FKM	FPM
G 1/8 B	11251051	-	-	-	-
G 1/4 B	11250810	11250844	-	-	-
G 1/2 B	11250861	11251042	-	-	-
G 3/8 B	11250861	-	-	-	-
M12 x 1.5	11250810	11250844	-	-	-
M20 x 1.5	11250861	11251042	-	-	-
G 1/4 A	-	-	1537857	1576534	1576534
G 1/2 A	-	-	1039067	1039075	-
M14 x 1.5	-	-	1537857	1576534	-
7/16-20 UNF BOSS	-	-	14057554	11472022	-
9/16-18 UNF BOSS	-	-	14057555	2063240	-

Ordering information

Model / Measuring range / Overpressure limit / Output signal / Non-linearity / Calibration temperature / Zero point adjustment / Process connection / Pressure channel / Sealing / Electrical connection / Assembly / Cable length / Shielding / Certificates / Packaging / Instrument labelling / Accessories and spare parts